



Key Parameters

V_{DRM} / V_{RRM}	3200V ... 3600V
I_{TAVM}	3560A ($T_C=85^\circ\text{C}$)
I_{TSM}	91000A
V_{TO}	0,826V
r_T	0,143m Ω
R_{thJC}	5,0K/kW
Clamping Force	63 ... 91kN
Max. Diameter	151,5mm
Contact Diameter	100mm
Height	35mm



For type designation please refer to actual shortform catalog

<http://www.ifbip.com/catalog>

Merkmale

- Volle Sperrfähigkeit 50/60Hz über einen weiten Temperaturbereich
- Hohe DC Sperrstabilität
- Hohe Stoßstrombelastbarkeit
- Hoher Gehäusebruchstrom
- Hohe Einschalt di/dt Fähigkeit

Features

- Full blocking 50/60Hz over a wide range temperature range
- High DC blocking stability
- High surge current capability
- High case non-rupture current
- High di/dt capability

Typische Anwendungen

- Hochstrom-Gleichrichter
- Gleichrichter für Antriebsapplikationen
- Mittelspannungsumrichter
- Lastgeführte Umrichter
- Kurzschliesser Applikationen

Typical Applications

- High Current Rectifier
- Rectifier for Drives Applications
- Medium Voltage Drives
- Load Commutating Inverter
- Crowbar Applications

content of customer DMX code	DMX code digit	DMX code digit quantity
serial number	1..7	7
SP material number	8..16	9
datecode (production day)	17..18	2
datecode (production year)	19..20	2
datecode (production month)	21..22	2
vT class	23..26	4
QR class	27..30	4

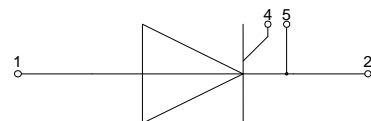

www.ifbip.com
support@infineon-bip.com



Technische Information / technical information



Infineon Technologies Bipolar
 GmbH & Co. KG

Netz-Thyristor Phase Control Thyristor

T3401N

Elektrische Eigenschaften / electrical properties Höchstzulässige Werte / maximum rated values

Periodische Vorwärts- und Rückwärts-Spitzensperrspannung repetitive peak forward off-state and reverse voltage	$T_{vj} = -40^{\circ}\text{C} \dots T_{vj\text{ max}}$	$V_{\text{DRM}}, V_{\text{RRM}}$	3200 V 3400 V 3600 V
Durchlaßstrom-Grenzeffektivwert maximum RMS on-state current	$T_C = 85^{\circ}\text{C}$	I_{TRMSM}	5600 A
Dauergrenzstrom average on-state current	$T_C = 85^{\circ}\text{C}$ $T_C = 70^{\circ}\text{C}$ $T_C = 55^{\circ}\text{C}$	I_{TAVM}	3560 A 4330 A 5000 A
Stoßstrom-Grenzwert surge current	$T_{vj} = 25^{\circ}\text{C}, t_p = 10\text{ ms}$ $T_{vj} = T_{vj\text{ max}}, t_p = 10\text{ ms}$	I_{TSM}	91000 A 87000 A
Grenzlastintegral I^2t -value	$T_{vj} = 25^{\circ}\text{C}, t_p = 10\text{ ms}$ $T_{vj} = T_{vj\text{ max}}, t_p = 10\text{ ms}$	I^2t	41400 $10^3\text{ A}^2\text{s}$ 37850 $10^3\text{ A}^2\text{s}$
Kritische Stromsteilheit critical rate of rise of on-state current	DIN IEC 60747-6 $f = 50\text{ Hz}, i_{\text{GM}} = 3\text{ A}, di_{\text{G}}/dt = 6\text{ A}/\mu\text{s}$	$(di_{\text{T}}/dt)_{\text{cr}}$	300 $\text{A}/\mu\text{s}$
Kritische Spannungssteilheit critical rate of rise of off-state voltage	$T_{vj} = T_{vj\text{ max}}, V_{\text{D}} = 0,67 V_{\text{DRM}}$ 5.Kennbuchstabe / 5 th letter H	$(dv_{\text{D}}/dt)_{\text{cr}}$	1000 $\text{V}/\mu\text{s}$

Charakteristische Werte / characteristic values

Durchlaßspannung on-state voltage	$T_{vj} = T_{vj\text{ max}}, i_{\text{T}} = 4000\text{ A}$	V_{T}	typ. 1,3 V Max. 1,4 V
Schleusenspannung threshold voltage	$T_{vj} = T_{vj\text{ max}}$	$V_{(\text{TO})}$	typ. 0,772 V max. 0,826 V
Ersatzwiderstand slope resistance	$T_{vj} = T_{vj\text{ max}}$	r_{T}	typ. 0,131 mΩ Max. 0,143 mΩ
Durchlaßkennlinie on-state characteristic $v_{\text{T}} = A + B \cdot i_{\text{T}} + C \cdot \ln(i_{\text{T}} + 1) + D \cdot \sqrt{i_{\text{T}}}$	$400\text{ A} \leq i_{\text{F}} \leq 5000\text{ A}$ $T_{vj} = T_{vj\text{ max}}$	typ. max.	A 0,69572 B 0,0000003 C -0,03974 D 0,0147 A 0,7485 B 0,000009 C -0,04072 D 0,01505
Zündstrom gate trigger current	$T_{vj} = 25^{\circ}\text{C}, V_{\text{D}} = 12\text{ V}$	I_{GT}	max. 350 mA
Zündspannung gate trigger voltage	$T_{vj} = 25^{\circ}\text{C}, V_{\text{D}} = 12\text{ V}$	V_{GT}	max. 2,5 V
Nicht zündender Steuerstrom gate non-trigger current	$T_{vj} = T_{vj\text{ max}}, V_{\text{D}} = 12\text{ V}$ $T_{vj} = T_{vj\text{ max}}, V_{\text{D}} = 0,5 V_{\text{DRM}}$	I_{GD}	max. 20 mA max. 10 mA
Nicht zündende Steuerspannung gate non-trigger voltage	$T_{vj} = T_{vj\text{ max}}, V_{\text{D}} = 0,5 V_{\text{DRM}}$	V_{GD}	max. 0,4 V
Haltestrom holding current	$T_{vj} = 25^{\circ}\text{C}, V_{\text{D}} = 12\text{ V}$	I_{H}	max. 350 mA
Einraststrom latching current	$T_{vj} = 25^{\circ}\text{C}, V_{\text{D}} = 12\text{ V}, R_{\text{GK}} \geq 10\ \Omega$ $i_{\text{GM}} = 3\text{ A}, di_{\text{G}}/dt = 6\text{ A}/\mu\text{s}, t_{\text{g}} = 20\ \mu\text{s}$	I_{L}	max. 3 A
Vorwärts- und Rückwärts-Sperrstrom forward off-state and reverse current	$T_{vj} = T_{vj\text{ max}}$ $V_{\text{D}} = V_{\text{DRM}}, V_{\text{R}} = V_{\text{RRM}}$	$i_{\text{D}}, i_{\text{R}}$	max. 600 mA
Zündverzögerung gate controlled delay time	DIN IEC 60747-6 $T_{vj} = 25^{\circ}\text{C}, i_{\text{GM}} = 3\text{ A}, di_{\text{G}}/dt = 6\text{ A}/\mu\text{s}$	t_{gd}	max. 2 μs

prepared by: TM	date of publication: 2011-05-02
approved by: JP	revision: 8.0



Technische Information / technical information



Infineon Technologies Bipolar
 GmbH & Co. KG

Netz-Thyristor Phase Control Thyristor

T3401N

Elektrische Eigenschaften / electrical properties Charakteristische Werte / characteristic values

Freiwerdezeit circuit commutated turn-off time	$T_{vj} = T_{vj\max}$, $i_{TM} = I_{TAVM}$ $V_{RM} = 100\text{ V}$, $V_{DM} = 0,67 V_{DRM}$ $dv_D/dt = 20\text{ V}/\mu\text{s}$, $-di_T/dt = 10\text{ A}/\mu\text{s}$ 4.Kennbuchstabe / 4 th letter O	t_q	typ.	300	μs
Sperrverzögerungsladung recovered charge	$T_{vj} = T_{vj\max}$ $i_{TM} = I_{TAVM}$, $-di_T/dt = 10\text{ A}/\mu\text{s}$ $V_R = 0,5V_{RRM}$, $V_{RM} = 0,8V_{RRM}$	Q_r	max.	10,5	mAs
Rückstromspitze peak reverse recovery current	$T_{vj} = T_{vj\max}$ $i_{TM} = I_{TAVM}$, $-di_T/dt = 10\text{ A}/\mu\text{s}$ $V_R = 0,5V_{RRM}$, $V_{RM} = 0,8V_{RRM}$	I_{RM}	max.	300	A

Thermische Eigenschaften / thermal properties

Innerer Wärmewiderstand thermal resistance, junction to case	<u>Kühlfläche / cooling surface</u> beidseitig / two-sided, $\theta = 180^\circ\text{sin}$ beidseitig / two-sided, DC Anode / anode, DC Kathode / cathode, DC	R_{thJC}	max.	5,4	K/kW
			max.	5,0	K/kW
			max.	9,0	K/kW
			max.	11,2	K/kW
Übergangs-Wärmewiderstand thermal resistance, case to heatsink	<u>Kühlfläche / cooling surface</u> beidseitig / two-sided einseitig / single-sided	R_{thCH}	max.	1,5	K/kW
			max.	3,0	K/kW
Höchstzulässige Sperrschichttemperatur maximum junction temperature		$T_{vj\max}$		125	$^\circ\text{C}$
Betriebstemperatur operating temperature		$T_{c\text{op}}$		-40...+125	$^\circ\text{C}$
Lagertemperatur storage temperature		T_{stg}		-40...+150	$^\circ\text{C}$

Mechanische Eigenschaften / mechanical properties

Gehäuse, siehe Anlage case, see annex				Seite 4 page 4	
Si-Element mit Druckkontakt Si-pellet with pressure contact					
Anpresskraft clamping force		F		63...91	kN
Steueranschlüsse control terminals	DIN 46244	Gate Kathode /Cathode		A 4,8x0,8 A 6,3x0,8	
Gewicht weight		G	typ.	3000	g
Kriechstrecke creepage distance				49	mm
Schwingfestigkeit vibration resistance	f = 50 Hz			50	m/s ²

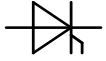

Technische Information /
technical information



Netz-Thyristor
Phase Control Thyristor

T3401N

Infineon Technologies Bipolar
GmbH & Co. KG

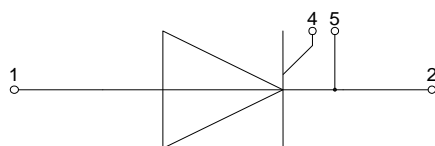
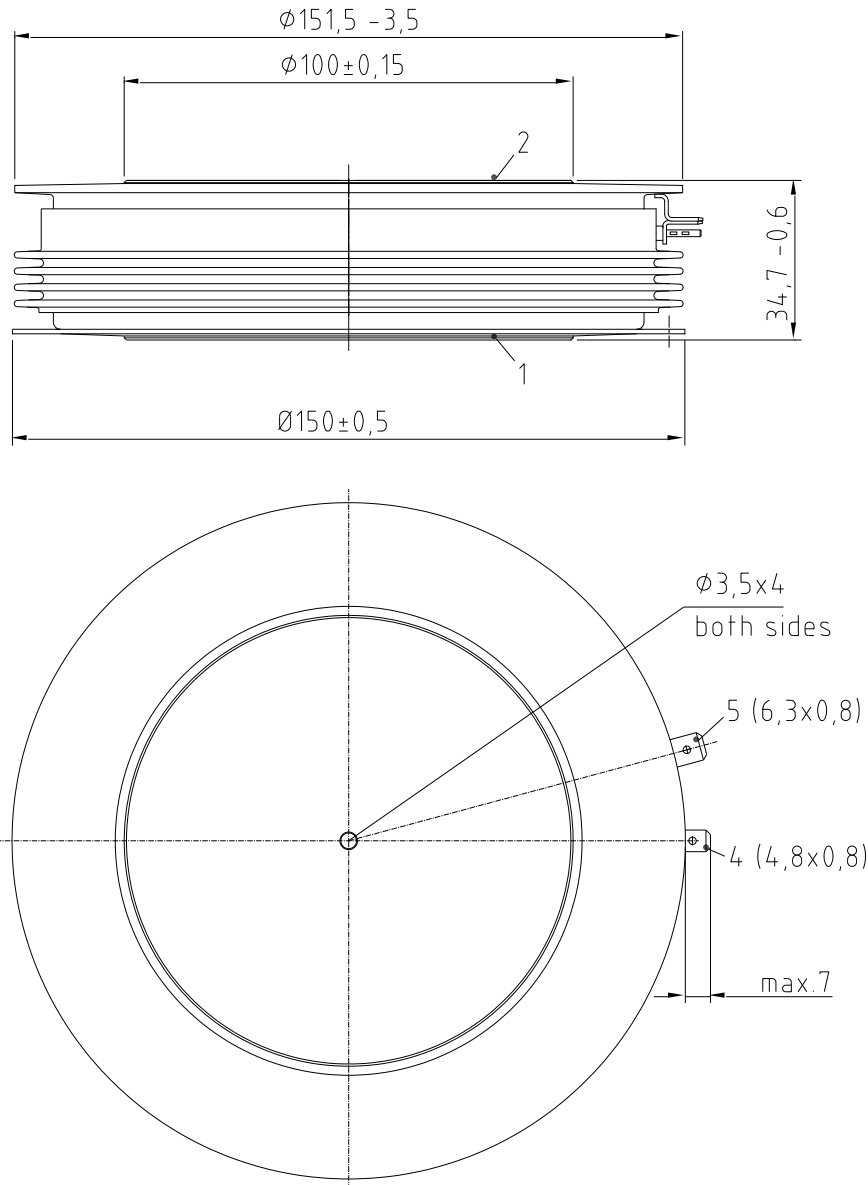

- 1: Anode/anode
- 2: Kathode/cathode
- 4: Gate
- 5: Hilfskathode/
cathode (control terminal)



Analytische Elemente des transienten Wärmewiderstandes Z_{thJC} /
analytical elements of transient thermal impedance Z_{thJC}

	Pos. n	1	2	3	4	5	6	7
beidseitig two-sided	R_{thn} [K/kW]	1,58	2,16	0,42	0,55	0,29		
	τ_n [s]	2,05	0,25	0,09	0,0195	0,0055		
anodenseitig anode-sided	R_{thn} [K/kW]	5,58	2,16	0,42	0,55	0,29		
	τ_n [s]	7,2	0,25	0,09	0,0195	0,0055		
kathodenseitig cathode-sided	R_{thn} [K/kW]	7,78	2,16	0,42	0,55	0,29		
	τ_n [s]	10	0,25	0,09	0,0195	0,0055		

Analytische Funktion / analytical function:
$$Z_{thJC} = \sum_{n=1}^{n_{max}} R_{thn} \left(1 - e^{-\frac{t}{\tau_n}} \right)$$

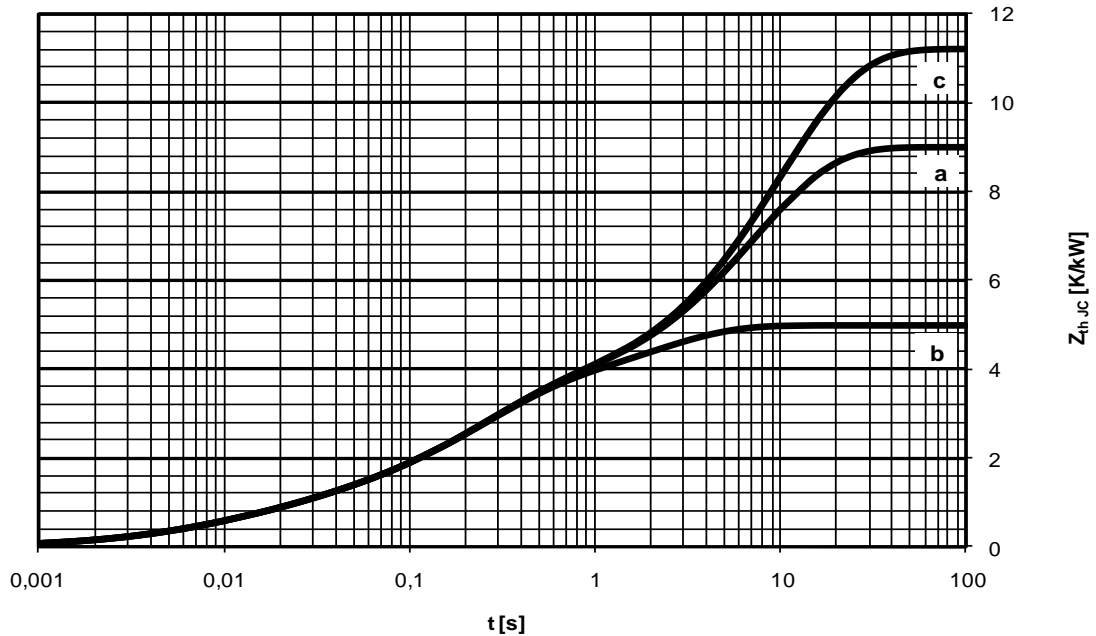

Transienter innerer Wärmewiderstand für DC / transient thermal impedance $Z_{thJC} = f(t)$ for DC

a : Anodenseitige Kühlung / anode-sided cooling

b : Beidseitige Kühlung / two-sided cooling

c : Kathodenseitige Kühlung / cathode-sided cooling

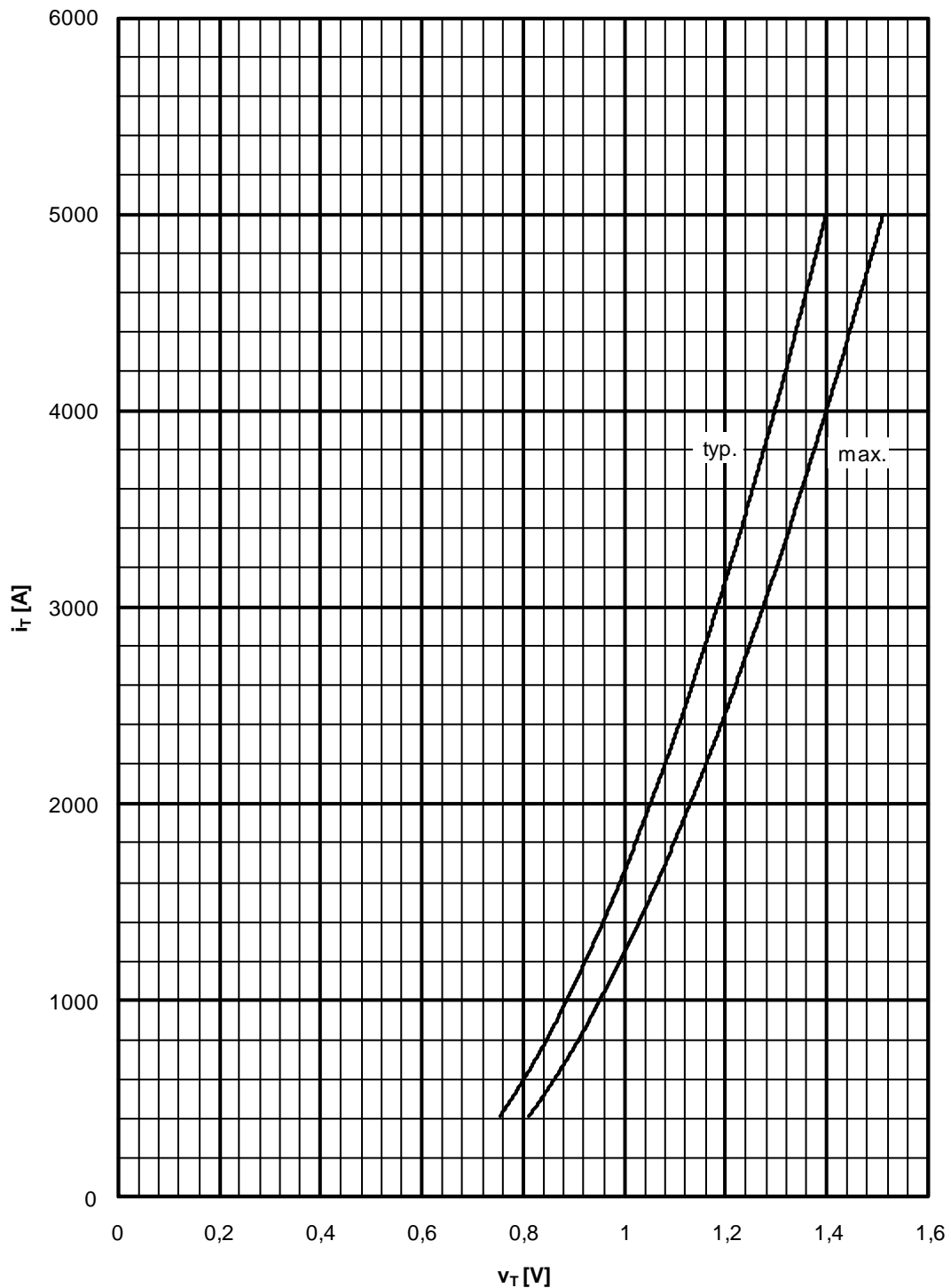

Grenzdurchlaßkennlinie / limiting on-state characteristic $i_T = f(v_T)$

$$T_{vj} = T_{vj \text{ max}}$$

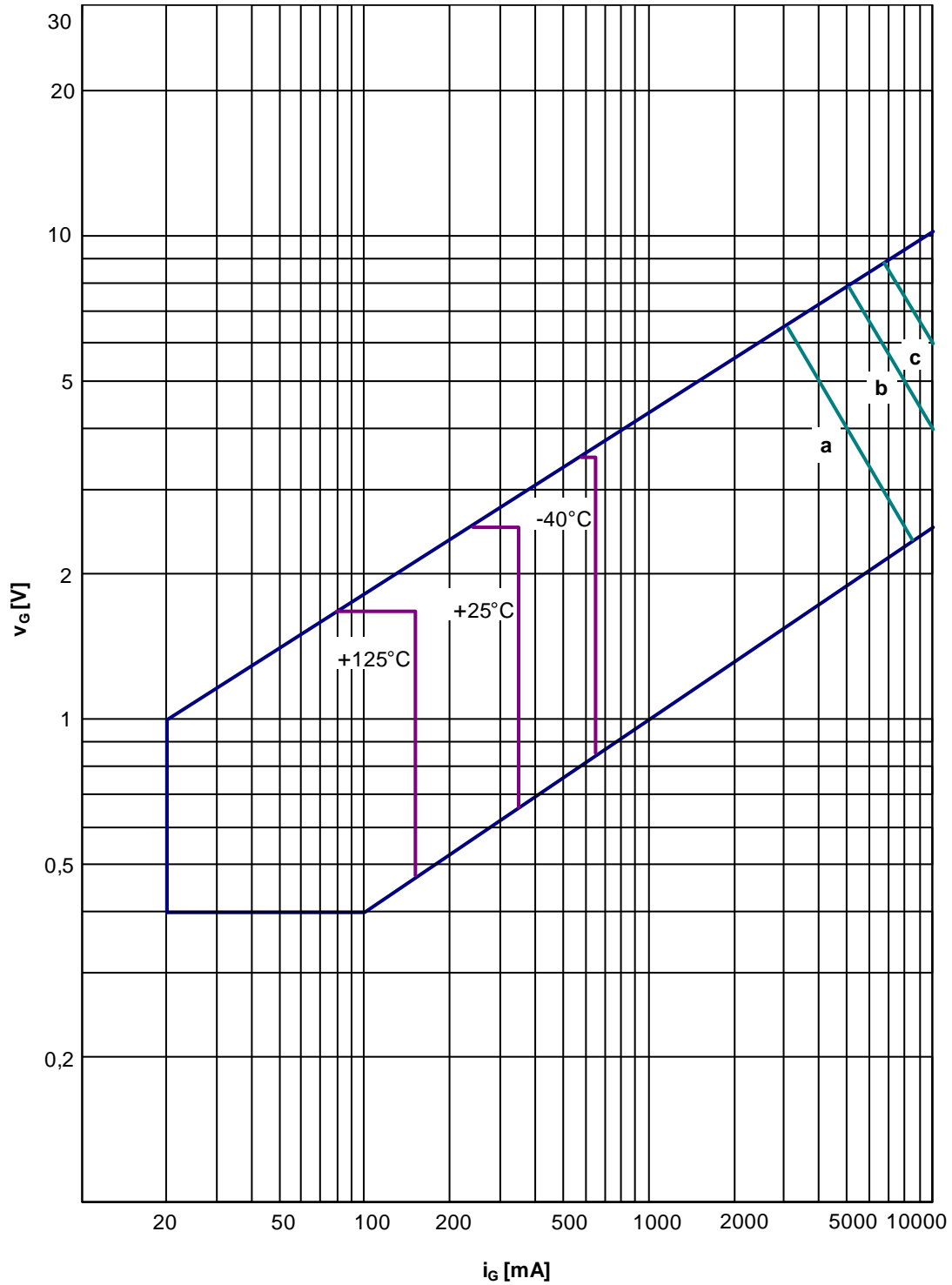

Steuercharakteristik $v_G = f(i_G)$ mit Zündbereichen für $V_D = 12$ V /
gate characteristic $v_G = f(i_G)$ with triggering area for $V_D = 12$ V

Höchstzulässige Spitzensteuerverlustleistung / maximum rated peak gate power dissipation $P_{GM} = f(t_g)$:

a - 20 W/10ms b - 40 W/1ms c - 60 W/0,5ms

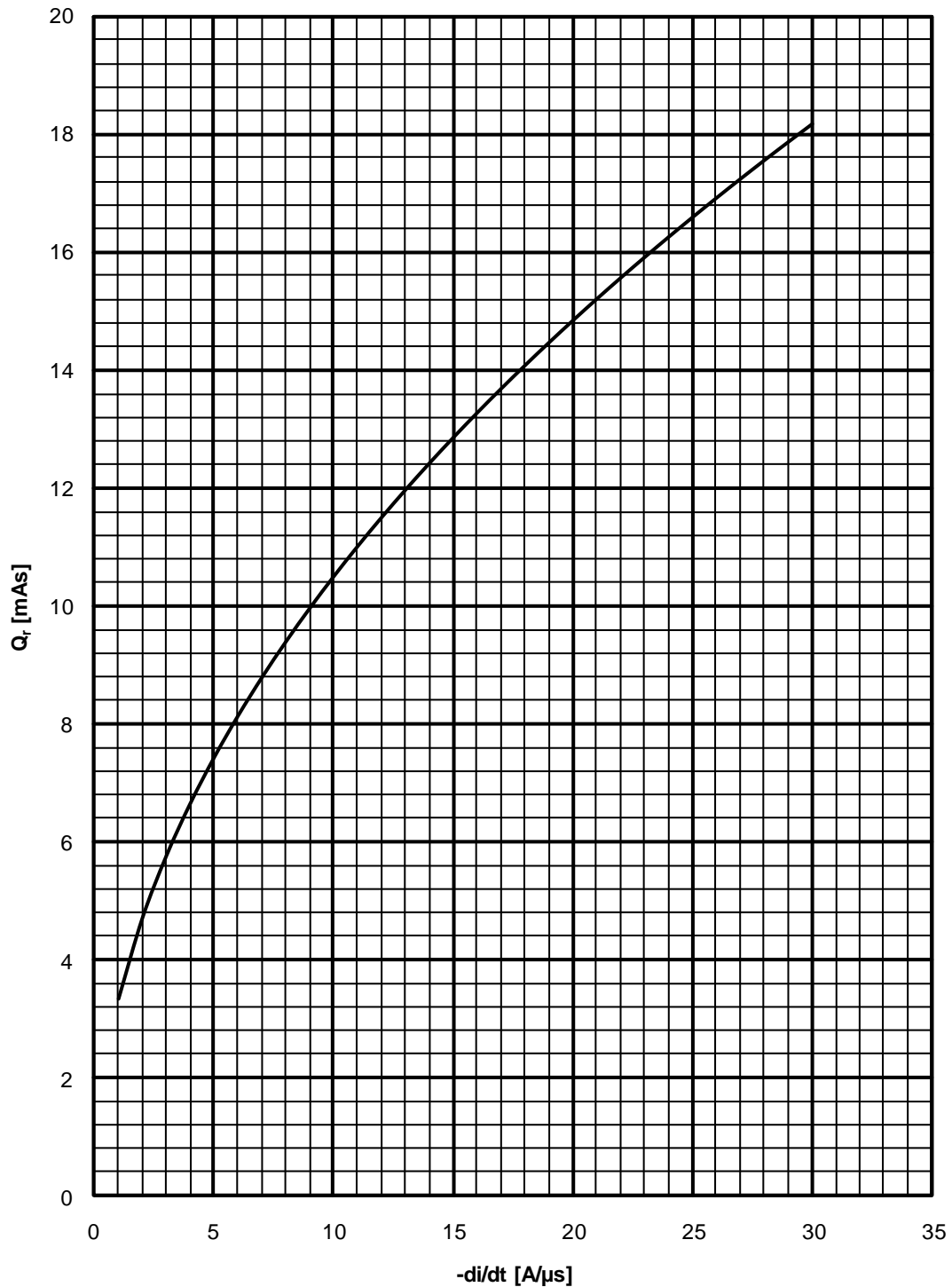

Sperrverzögerungsladung / recovered charge $Q_r = f(-di/dt)$

$$T_{vj} = T_{vjmax}, v_R = 0,5 V_{RRM}, V_{RM} = 0,8 V_{RRM}$$

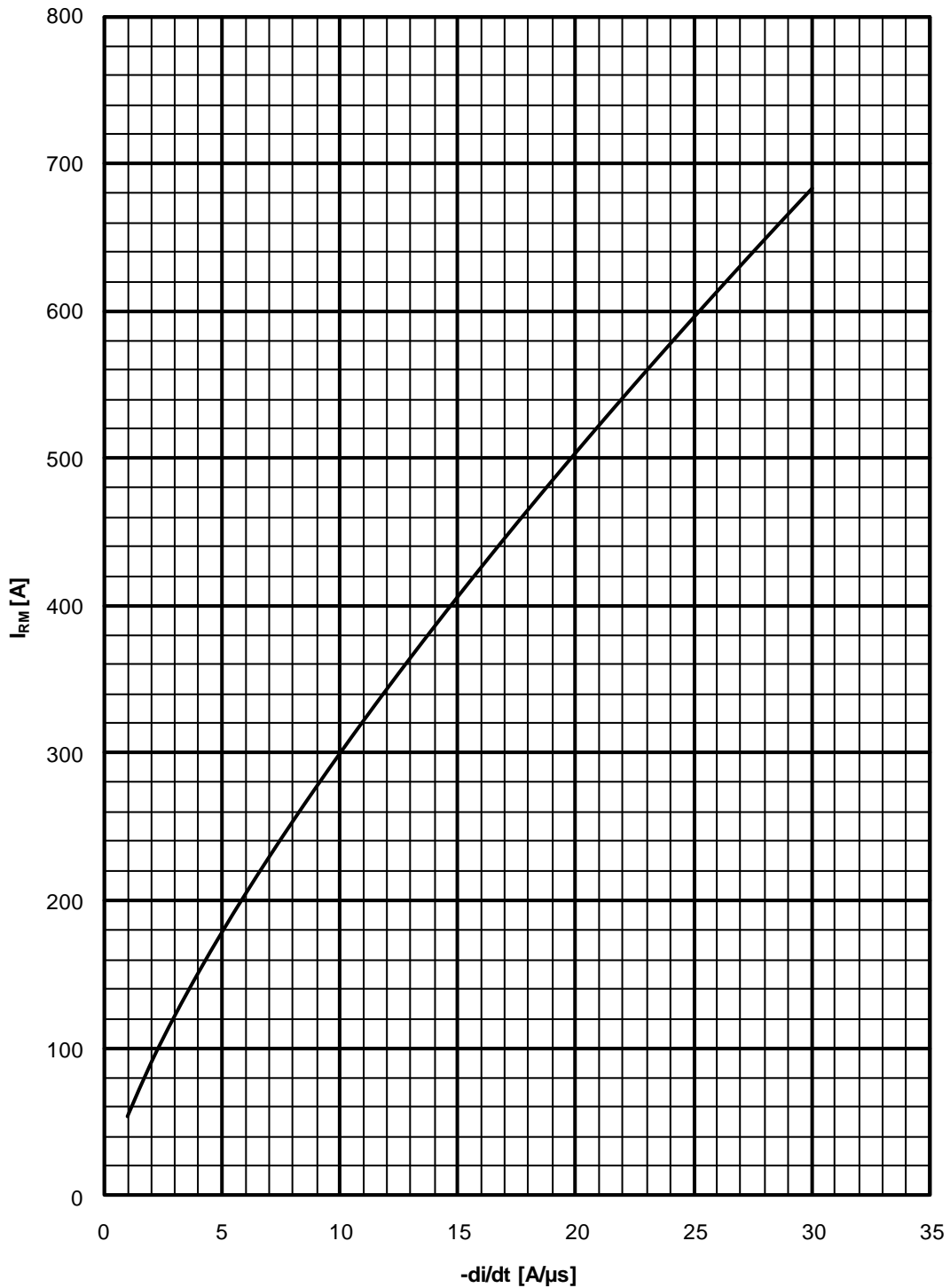

Rückstromspitze / peak reverse recovery current $I_{RM} = f(-di/dt)$

$T_{vj} = T_{vjmax}$, $V_R = 0,5 V_{RRM}$, $V_{RM} = 0,8 V_{RRM}$

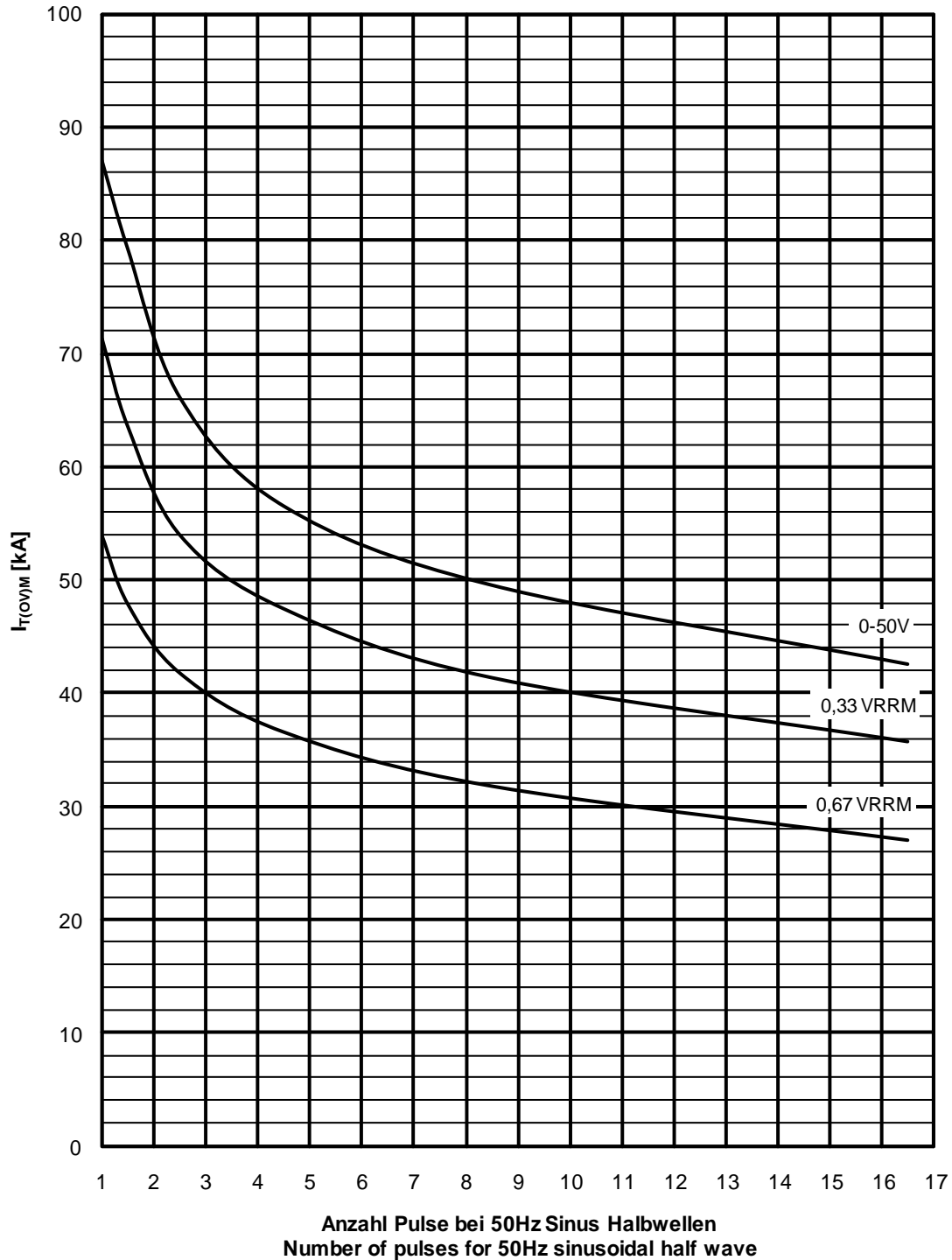

Typische Abhängigkeit des Grenzstromes $I_{T(OV)M}$ von der Anzahl für eine Folge von Sinus Halbwellen bei 50Hz.

Parameter: Rückwärtsspannung V_{RM}

Typical dependency of maximum overload on-state current $I_{T(OV)M}$ as a number of a sequence of sinusoidal half waves at 50Hz. Parameter: peak reverse voltage V_{RM}

$$I_{T(OV)M} = f(\text{pulses}, V_{RM}); T_{vj} = T_{vjmax}$$